

RAYO Industries



RU LED 4VPR | Surface Mounted



RU LED 4VPR | Suspended Mounted

SPECIFICATIONS	
MOUNTING	SURFACE/SUSPENDED
CRI	80/90+
CCT	2700-6500K
SUITABLE LOCATION	WET
WARRANTY	5 YEARS
DIMMABLE	None/0~10V/TRIAC
MAXIMUM WATTAGE	40W
VOLTAGES	120V/277V/120V~277 V AC

Project	
Project Name	
Fixture Location	
Date	

DESCRIPTION

- A dustproof, moisture-proof and anti-corrosion product.

FEATURES

- Using the energy -saving highlighting 5630 SMD LED light source.
- Module is replaceable.
- Surface mounted or suspended mounted.
- Using isolation constant-current driver power.
- Suit for the garage, warehouse, basement and car parks and other places to provide general illumination.
- Emergency system is available.

DIMENSIONS

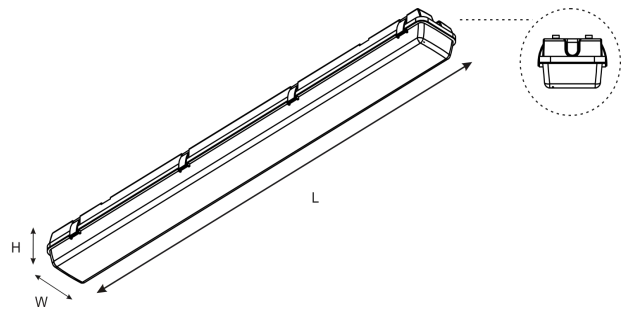

W: 4 3/4"

H: 3 5/16"

L: 4FT

