

RFRJ5-IA-F | New Construction

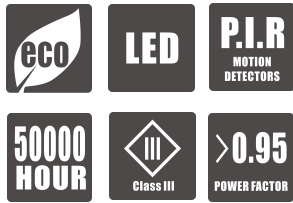

RETROFIT TYPE	
RETROFIT TYPE	5" RETROFIT/PAR30 BULB
VOLTAGE	120V AC/277V AC
FREQUENCY	50/60 Hz
DIMMING	TRIAC/ELV/NONE

SPECIFICATIONS	
MOUNTING	RECESSED
FIRE RATING	2 HOURS
CRI	80+/90+
PF	>0.95



Project	
Project Name	
Fixture Location	
Date	

DESCRIPTION

- 5" fire and sound rated downlight housing.

FEATURES

- Can be fitted to a wide range of 5" retrofit stands.
- The cULus Listed housing is rated for a minimum of 2 hours protection.

HOUSING

- Fire and sound rated housing, up to 120 minute fire rated L500(floor-ceiling) & P500(roof-ceiling) design.
- Die formed cool steel construction. Snap on cool steel cover. Non-combustible matt insulation.

JUNCTION BOX

- 4 in 4 out galvanized steel junction box.

DIMENSIONS

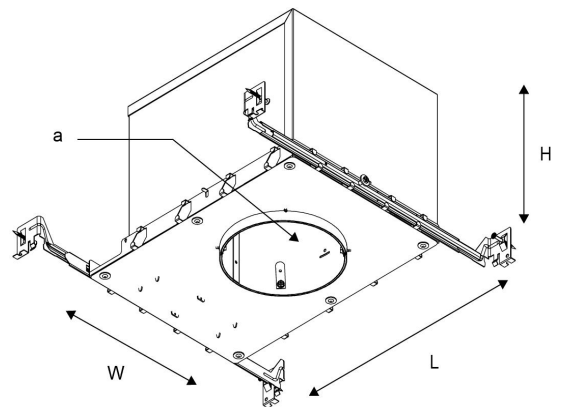

L: 12 5/8"

W: 9 1/16"

H: 7 3/4"

a: 5"

Designed for 2" x 8" joist construction